

Front view

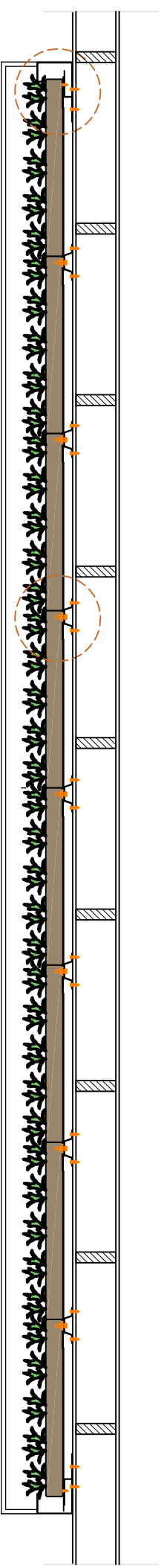

Section B-B

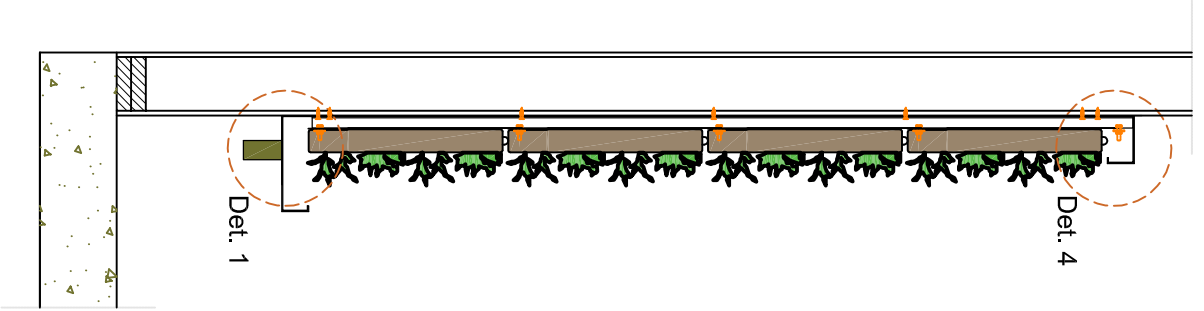

Section A-A

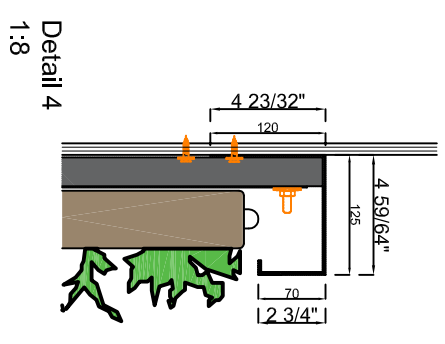
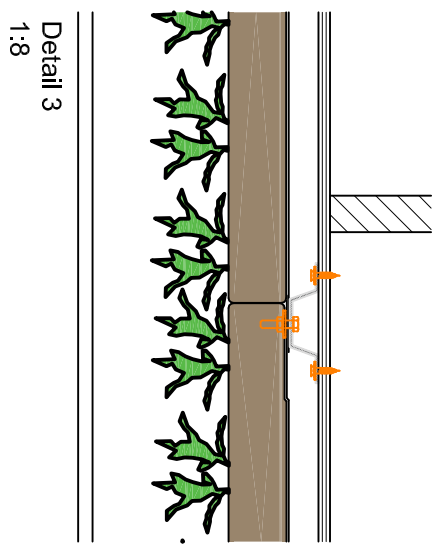
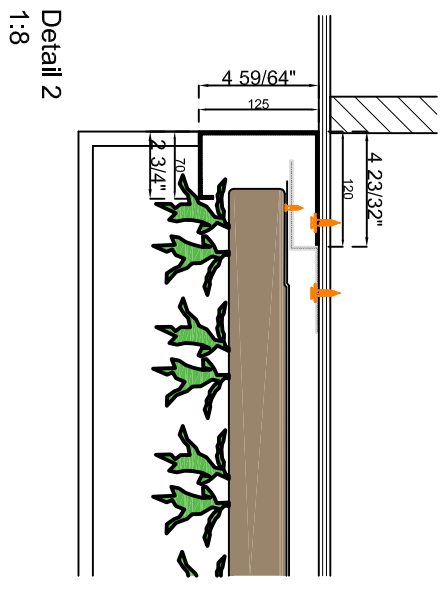
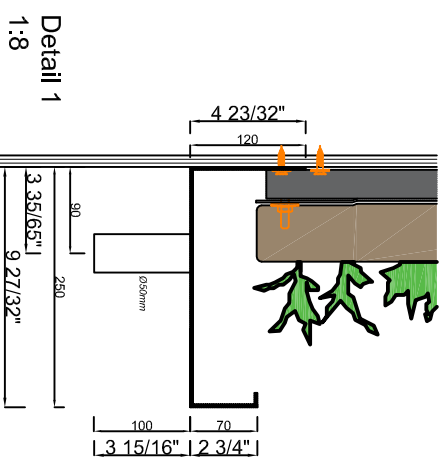

Cradle to Cradle certified

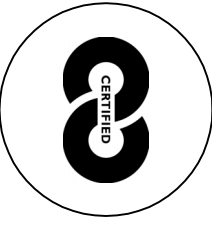

Max. saturated weight

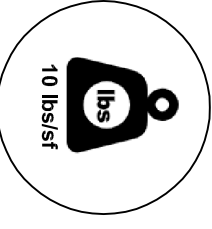

Web-based irrigation system

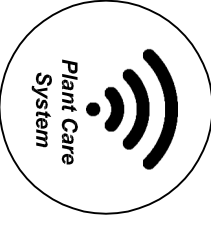

Warranty Flexipanel

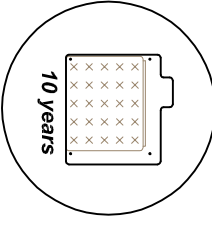

sempergreen wall
 www.sempergreenwall.com
 Description: SemperGreenwall Indoor
 Scale: 1:20 / 1:8
 Size: Letter
 Date: 19/05/2021
 Drawing no.: SGWI-H01

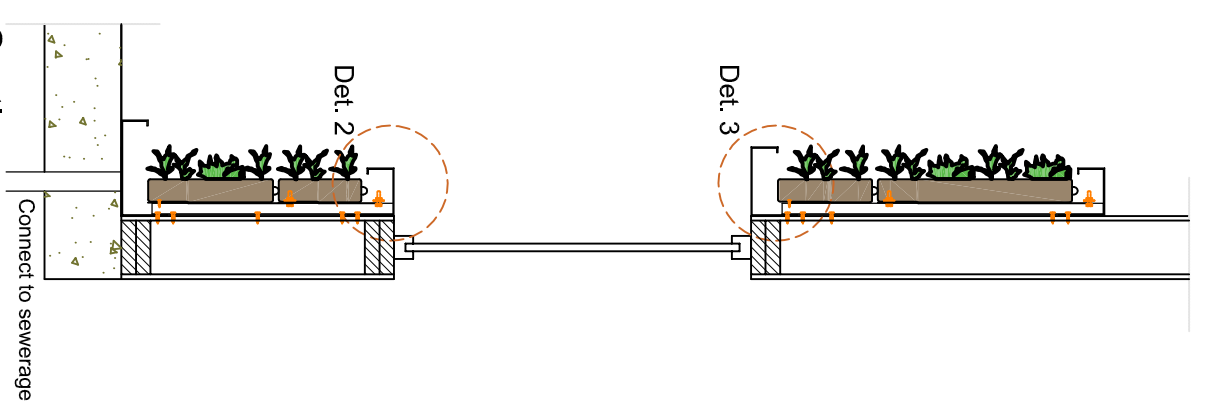
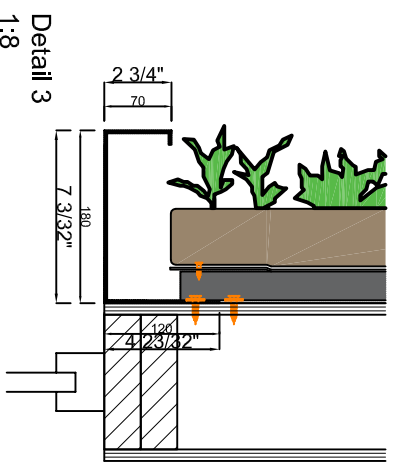
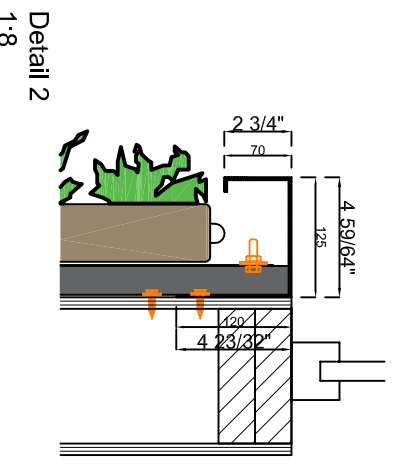
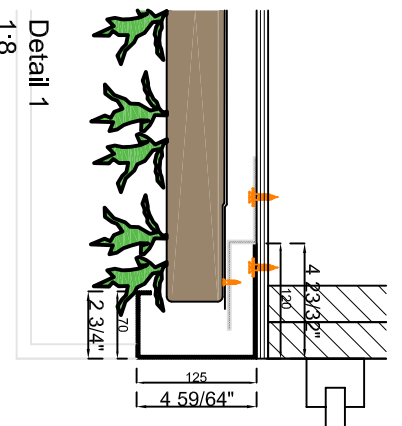
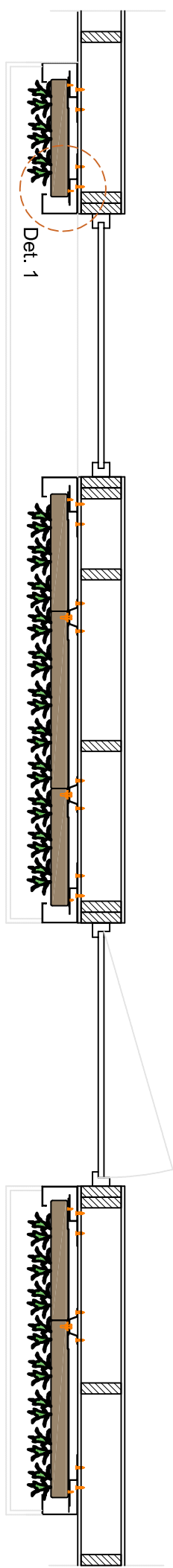
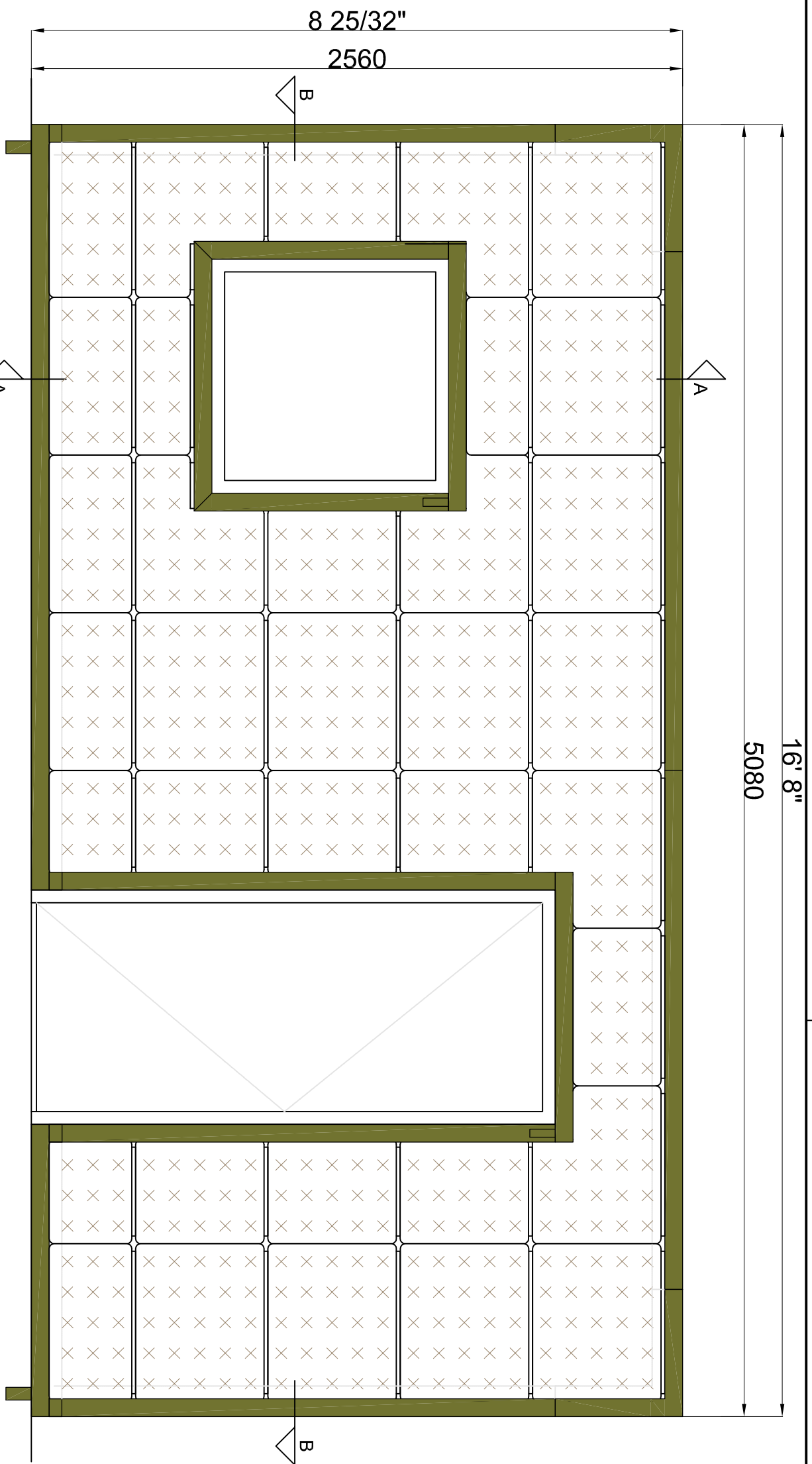

Cradle to Cradle certified

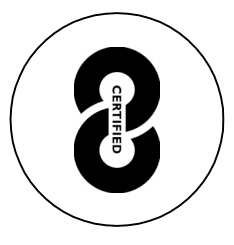

Max. saturated weight

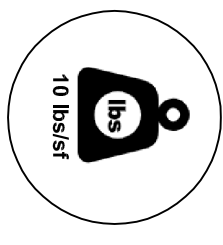

Web-based irrigation system



Warranty Flexipanel

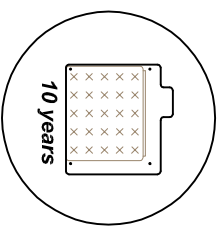

Description
SemperGreenwall
Indoor window/door details

Scale
1:20 / 1:8

Size
Letter

Date
19/05/2021

Drawing no.
SGWI-H02



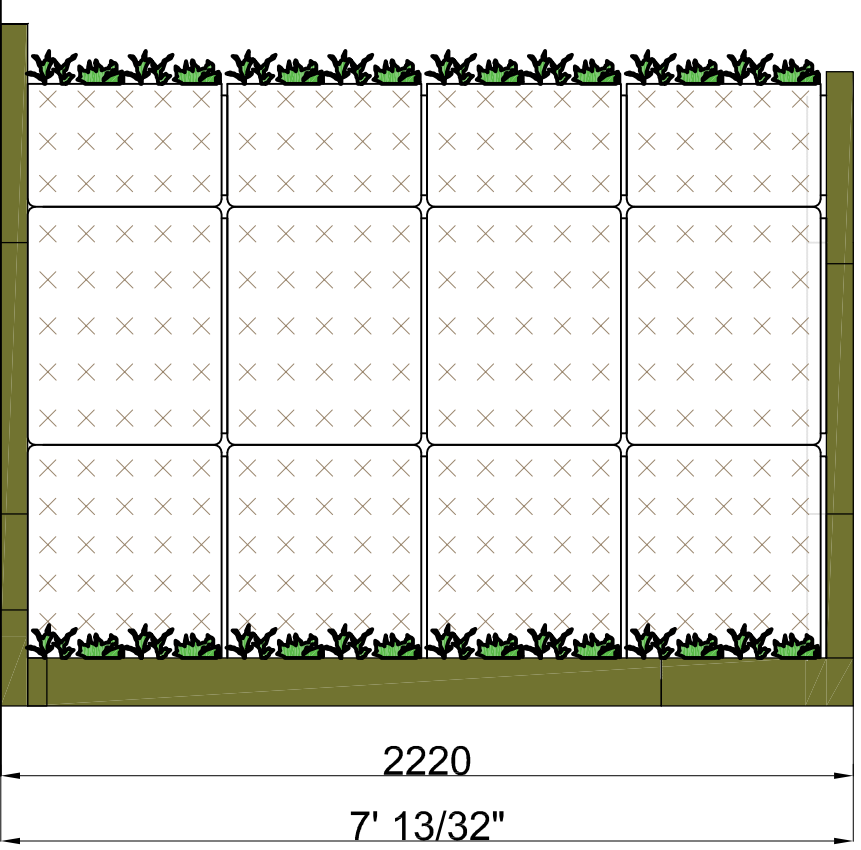
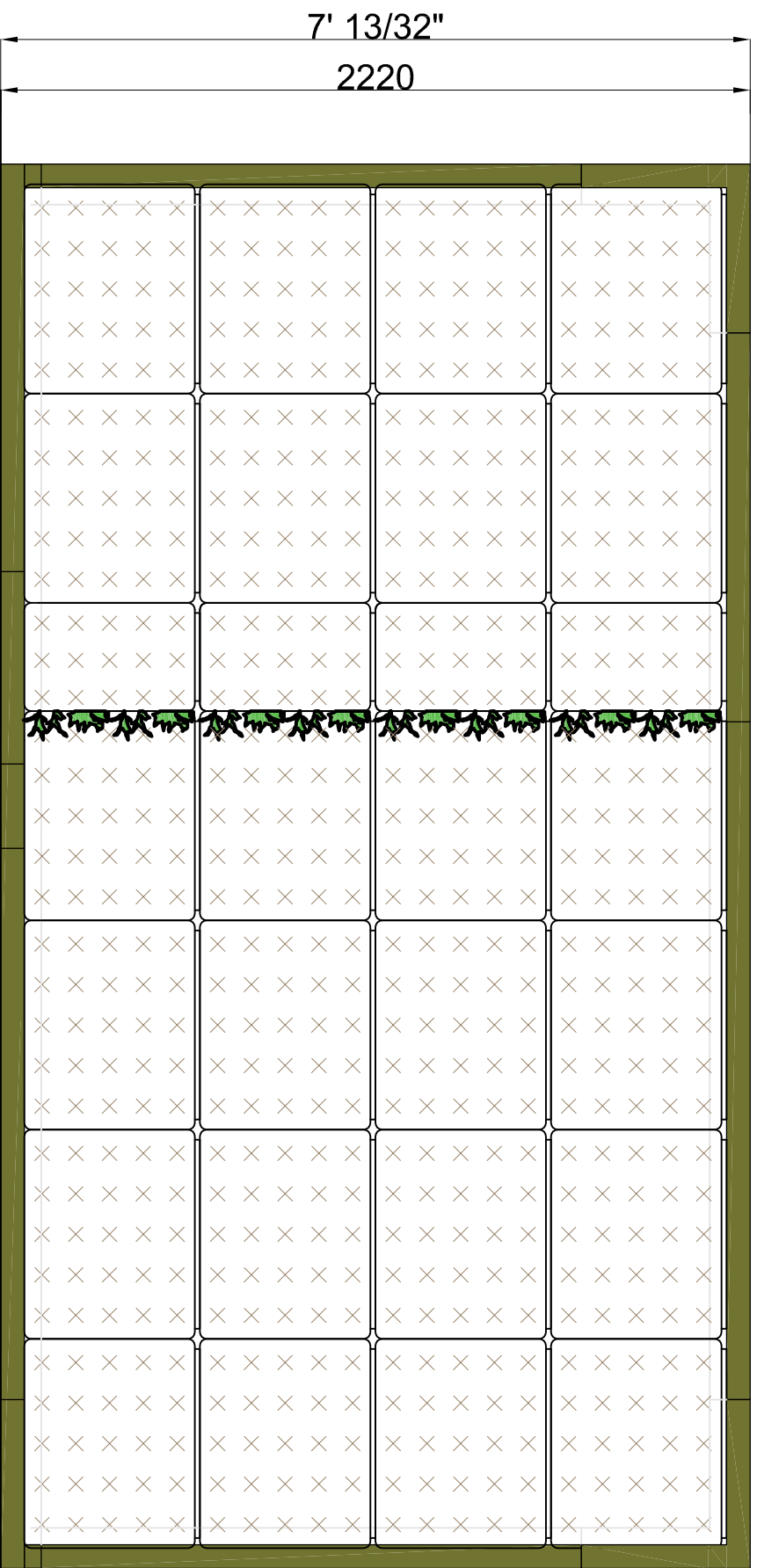

View A

View B

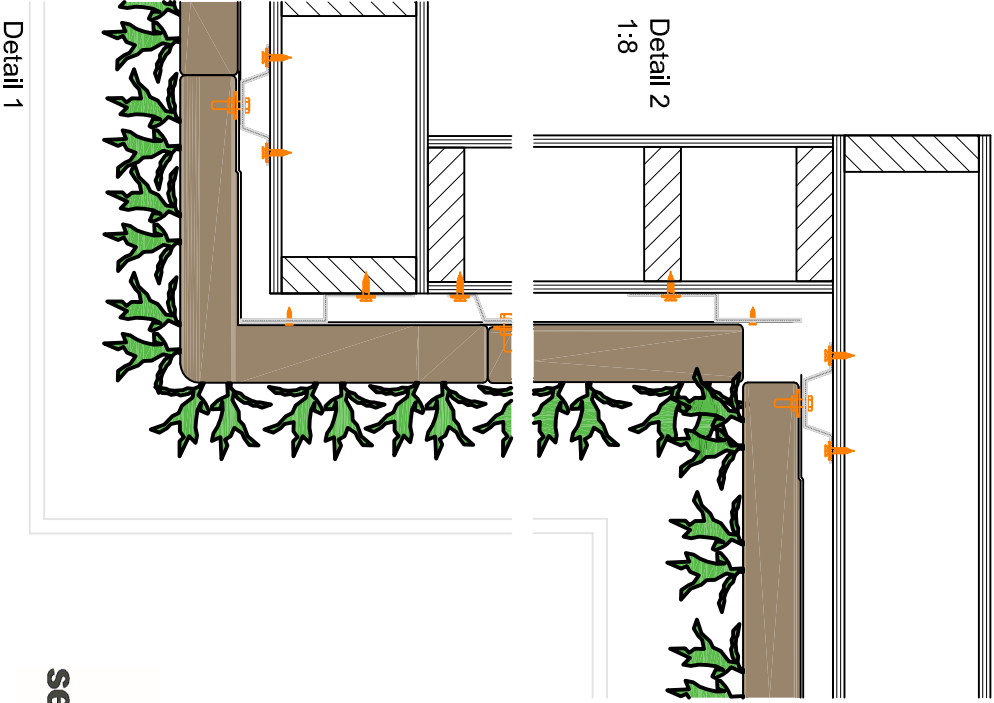
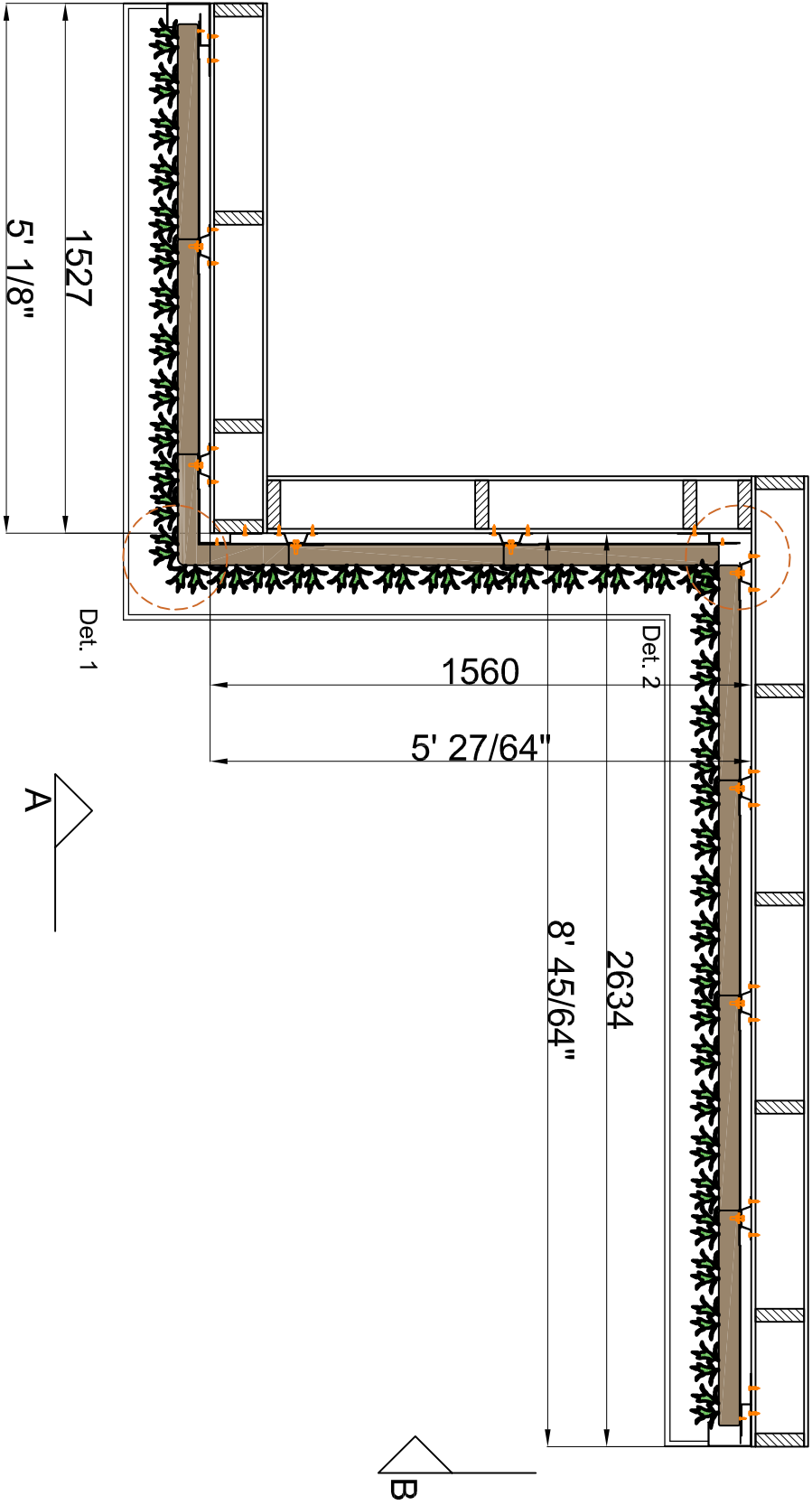

Cradle to Cradle certified

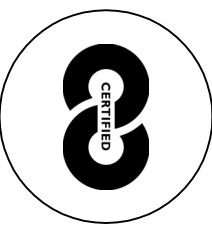

Max. saturated weight



Web-based irrigation system



Warranty Flexipanel

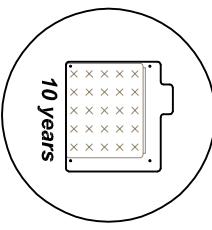

Description
SemperGreenwall
Indoor corner details

Scale
1:20 / 1:8

Size
Letter

Date
19/05/2021

Drawing no.
SGWH-H03



www.sempergreenwall.com

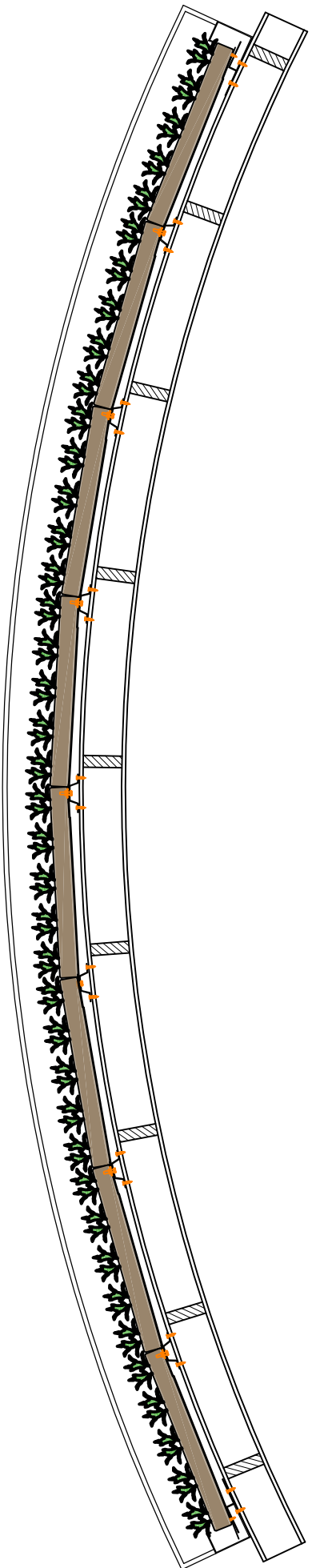

Cradle to Cradle certified

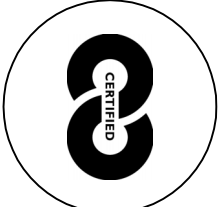

Max. saturated weight



Web-based irrigation system



Warranty Flexipanel

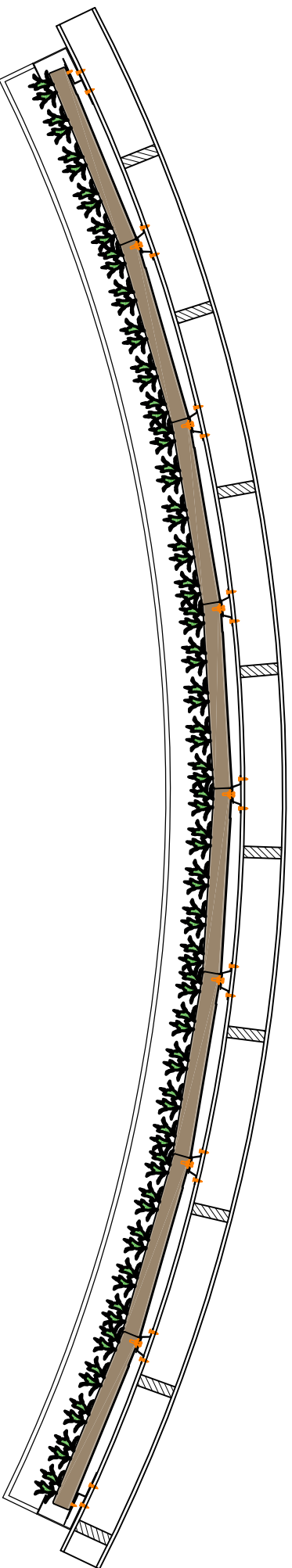
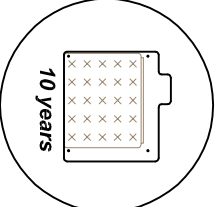

Description
SemperGreenwall
Indoor curved wall

Scale
1:20

Size
Letter

Date
19/05/2021

Drawing no.
SGWH-H04